



LED INDICATOR REFERENCE CHART

Status Indicator LEDs

Solo 365 indicates events as follows:

When Idle:

 Slow flashing Green: Power on

 Solid Purple: System fault

 Flashing Orange: Delayed start

 Slow flashing Red: Consumable low

 Solid Red: Consumable empty

When Active:

 Fast flashing Blue: Testing normally

 Fast flashing Green: Clearing ready

 Fast flashing White: Clearing mode

 Slow flashing Red/Green: Timeout in testing or clearing modes

 Fast flashing Red: Consumable low

Torch LED

 Solid White: LED auto torch

Consumable LEDs Battery Cartridge Generator

 Flashing Red: Consumable low

 Solid Red: Consumable empty

Battery LED:

 Flashing Red/Green: Detecting level of charge

 Solid Green: Fully charged

 Solid Red: Charging

 Flashing Red: Fault

USING SOLO 365

5 Testing a detector

- 1 Hold the power button until the status indicator LEDs flash slow green.

Note:

With a new generator the unit will auto purge for several seconds.



Note:

A manual purge may be required after installing a generator. Hold down the function button for up to 15 seconds. (Page 13 in user manual)

- 2 Raise Solo 365 to the detector so it is fully enclosed within the cup to begin testing. During a test the status indicator LEDs will flash fast blue.

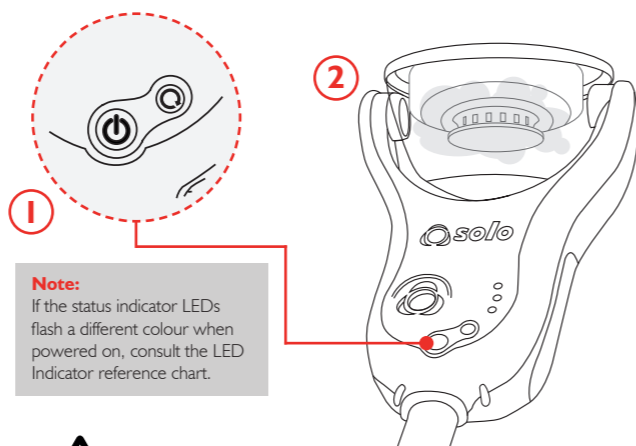

Note:

If the status indicator LEDs flash a different colour when powered on, consult the LED Indicator reference chart.



This product is intended to be used at height. Exercise great care and always wear PPE when operating above head height.

CLEARING A DETECTOR (OPTIONAL)

- 3 Once the detector is activated, lower Solo 365. Status Indicator LEDs will flash fast green, ready to enter clearing mode. If clearing is not required, wait for the status indicator LEDs to revert to a slow green flash (Idle).
- 4 Raise Solo 365 again to begin clearing, indicated by fast white flashing status indicator LEDs.

Note:

'Clearing' blows air into the detector to clear smoke. It does not clean internal components of a detector.

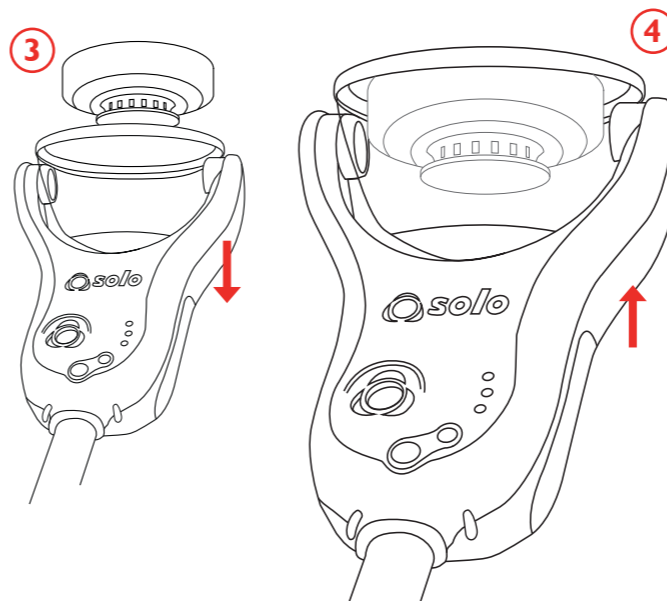

 solo™ 365
detectortesters



Quick
Start Guide

www.solo-tester.com

GETTING STARTED

1 Charging the battery

The battery is charged by connecting the battery pack to the powered USB socket using the supplied mains adapter or suitable source.

- Connect battery pack to the USB power supply using the supplied charger. (Ensure the battery is fully charged before use). Refer to LED indicator reference chart.

Note:

Read the cautions on Lithium Ion rechargeable batteries before use (Page 2 in user manual).

Note:

For optimum performance avoid charging the battery at low ambient temperatures. (Page 9 in user manual).

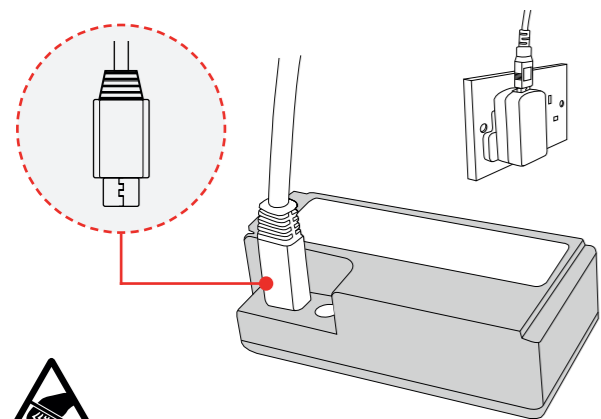

2 Installing the generator

Take care during installation of the product components not to touch exposed electrical contacts. Ensure that all components are securely fitted.

- Open the back cover.
- Insert generator firmly into recess, engaging clips **1** and **2**.

Note:

When replacing consumables, ensure that the unit is switched off before opening the back cover.

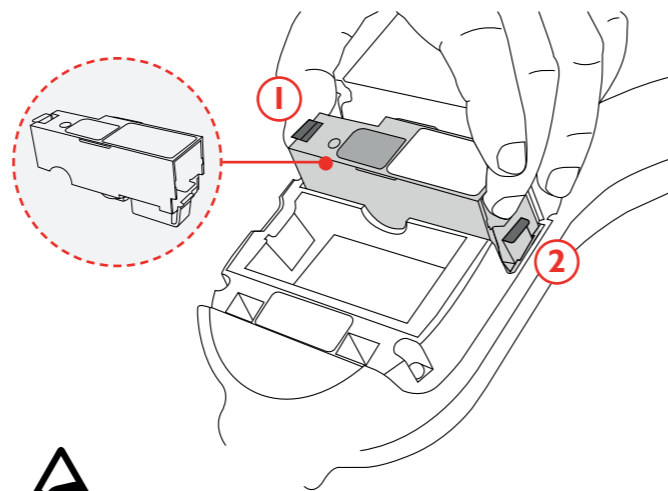

3 Inserting the smoke cartridge

- Slide the smoke cartridge completely into the generator housing following the guide rails.

Note:

Do not insert smoke cartridge until generator has been fully fitted into the main unit.

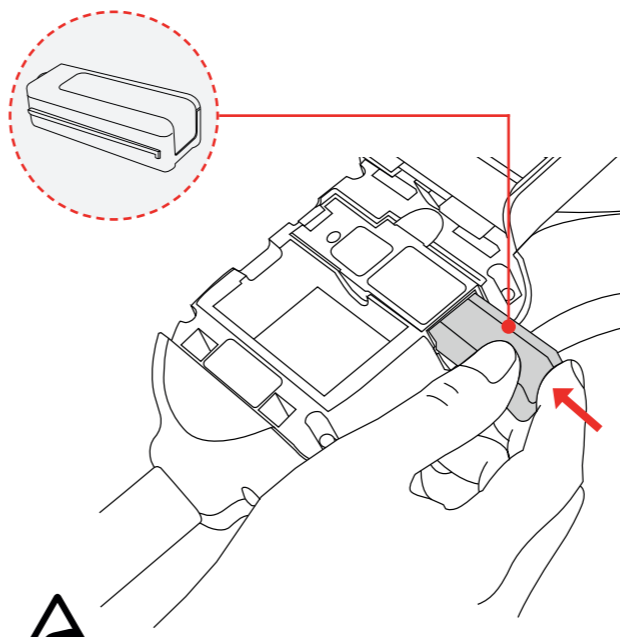

4 Inserting the battery

- Clip the battery into place and close the back cover.

Note:

Do not force the battery into place.

Note:

When recharging remove the battery from the unit.

